

# MMTV

Vertical Multi-Stage Pumps with Barrel



TORISHIMA PUMP

# Vertical Multi-Stage Pumps with Barrel

Using a high pressure vertical barrel centrifugal pump often presents advantages and ensures trouble-free operation, in those cases where the physical layout of the plant precludes the installation of the receiver vessel at a sufficient height to ensure adequate suction head for the pump under all operation conditions. This applies particularly in the case of condensers in power stations. The barrel of the pump serves as a pit, and by adding the required length of rising main, the pump can be installed at any depth desired.

## Applications

Pumping hot water and condensate in power stations, especially in cases where the suction head is restricted.

## Operating range

Capacities	up to 2,900m <sup>3</sup> /h (12,770U.S.gpm)
Total head	up to 490m (1600ft)
Pump suction pressure	up to 19.6bar (285psi)
Pump discharge pressure	up to 39.2bar (570psi)
Speed	up to 3,600min <sup>-1</sup>
Size	40 to 350mm (1½ to 14 in)

## Materials

Casing	Cast iron, Ductile iron, Stainless cast steel, Bronze
Impeller, the first stage	Stainless cast steel, Bronze, Cast steel
Impeller, the second stage or more	Cast iron, Ductile iron, 2%Ni cast iron
Shaft	Stainless cast steel, Bronze
	Stainless steel



## Design

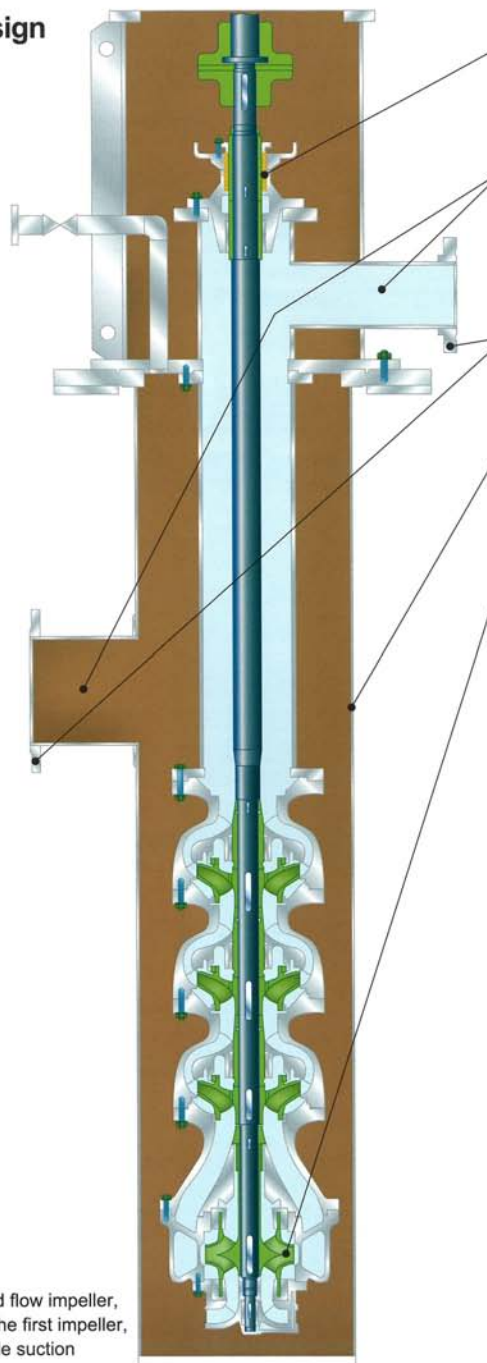

### Shaft seal options

- Gland packing
- Mechanical seal

### Nozzle locations

- Suction: Can be arranged above or below floor level as required.
- Discharge: Always located on the motor stool.

### Flange options

- to JIS, ANSI, DIN and BS

### Barrel

- Can be lengthened to meet low NPSH requirements.

### Impeller options

- Mixed flow impeller for high flow application. The first impeller: Specially designed with double suction to avoid cavitation also available.
- Radial impeller also available for high heat at low flow rate.

Mixed flow impeller,  
and the first impeller,  
double suction

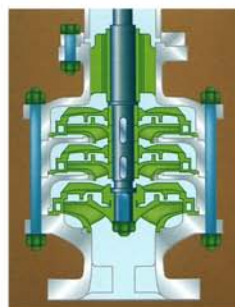

Radial impeller



Mixed flow impeller

# Selection Charts — 50Hz Applications.

**50Hz-2P (2900 1/min) — Radial Impeller**

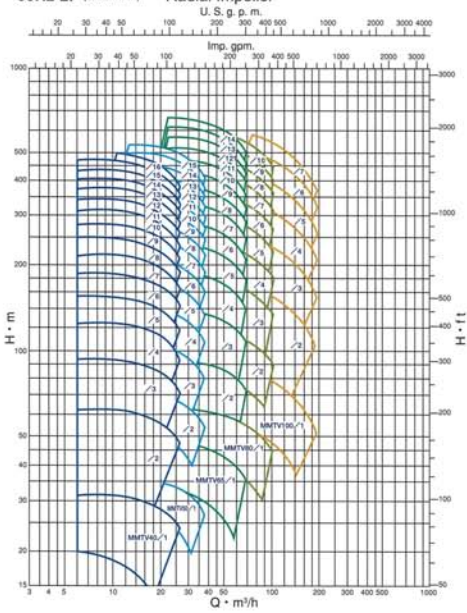

**50Hz-4P (1450 1/min) — Radial Impeller**

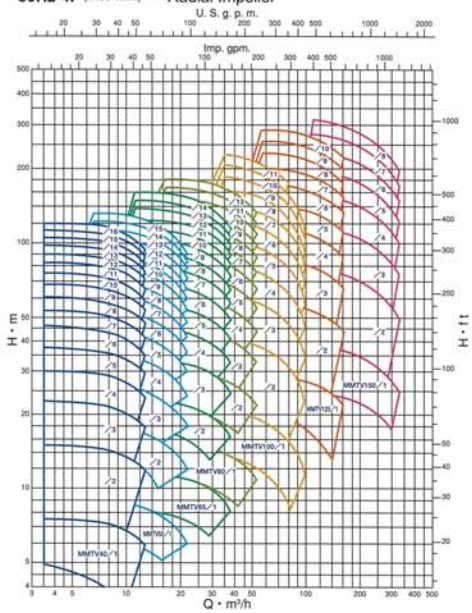

**50Hz-4P (1450 1/min) — Mixed-flow Impeller**

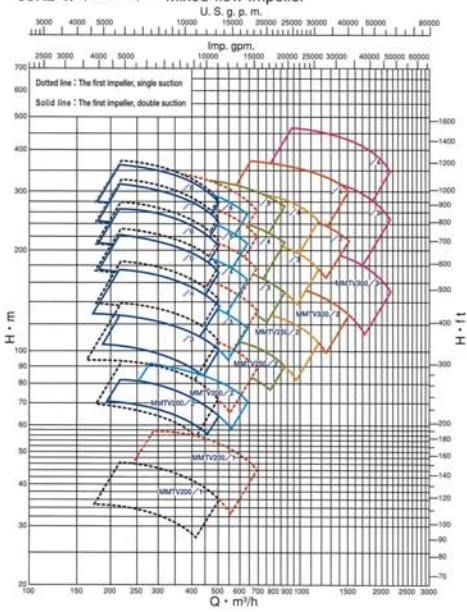

**50Hz-6P (970 1/min) — Mixed-flow Impeller**

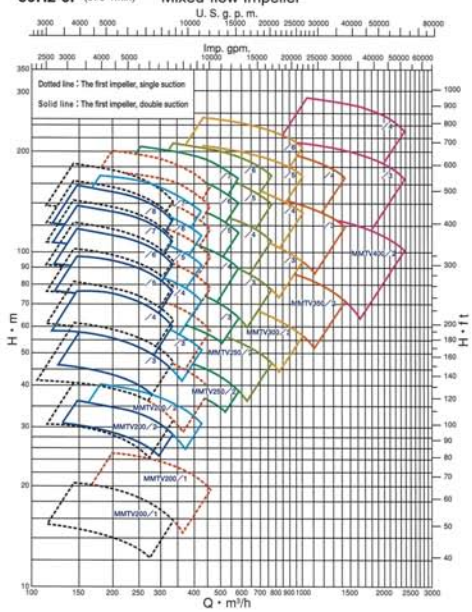

# Selection Charts – 60Hz Applications.

**60Hz-2P (3500 1/min) — Radial Impeller**

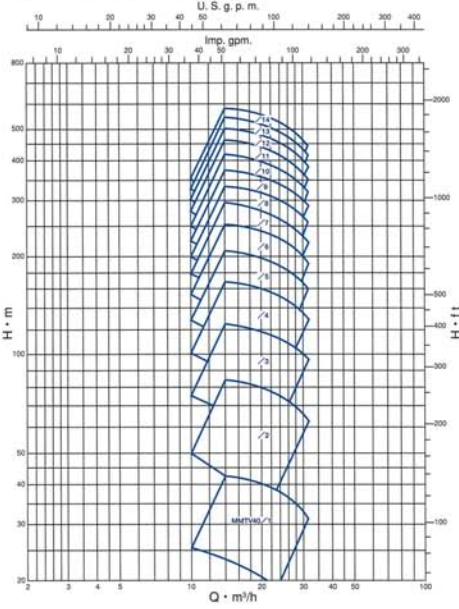

**60Hz-4P (1750 1/min) — Radial Impeller**

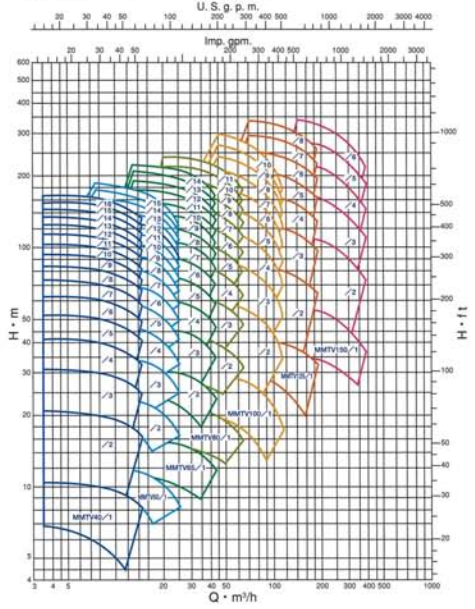

**60Hz-4P (1750 1/min) — Mixed-flow Impeller**

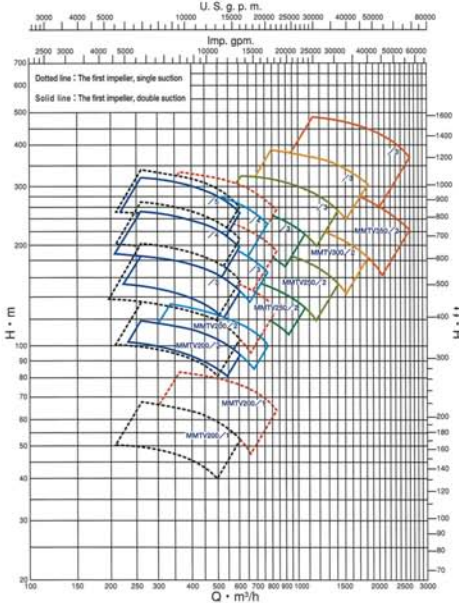

**60Hz-6P (1150 1/min) — Mixed-flow Impeller**

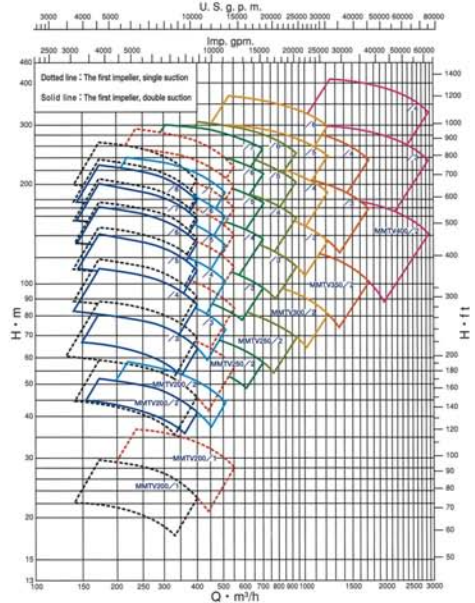

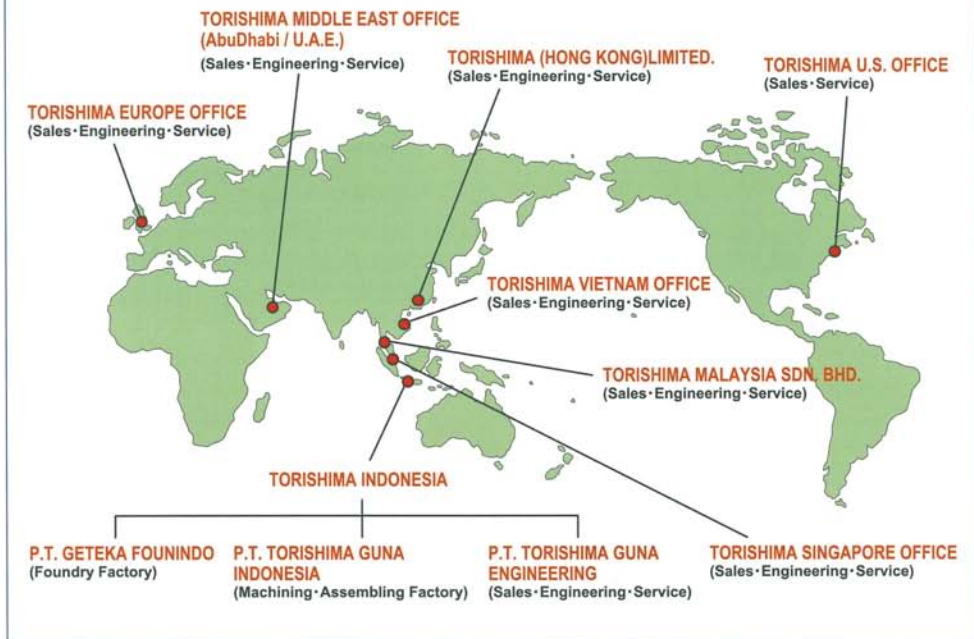

**TORISHIMA PUMP MFG. CO.,LTD.**

Head Office & Works: 1-1-8, Miyata-cho, Takatsuki City, Osaka, Japan. Phone: 072-695-0551 Fax: 072-693-1288

**TORISHIMA HONG KONG**

**TORISHIMA (HONG KONG) LIMITED**  
 Unit 605, 6/F., Tower II, Enterprise Square,  
 9 Sheung Yuet Road, Kowloon Bay,  
 Kowloon, Hong Kong  
 Phone: (852)2795-1838 Fax: (852)2754-3293

**TORISHIMA VIETNAM**

**VIETNAM OFFICE**  
 No.76 Bui Thi Xuan Street, Hai Ba Trung  
 District, Hanoi, Socialist Republic of Vietnam  
 Phone: (84)4-943-7880 Fax: (84)4-943-7876

**TORISHIMA SINGAPORE**

**SINGAPORE OFFICE**  
 30 Ubi Crescent #01-02 Ubi Techpark  
 Singapore 408566  
 Phone: (65)6779-0123 Fax: (65)6779-6900

**TORISHIMA MALAYSIA**

**TORISHIMA MALAYSIA SDN.BHD**  
 Suite 1906, 19th Floor Kenanga International  
 Jalan Sultan Ismail 50250 Kuala Lumpur,  
 Malaysia  
 Phone: (603)2715-0068 Fax: (603)2715-0019

**TORISHIMA INDONESIA**

**P.T. TORISHIMA GUNA INDONESIA**  
 Jalan Rawa Sumur Timur No.1, Pulogadung  
 Industrial Estate, P.O Box.:1160,  
 Jakarta Indonesia  
 Phone: (62)021-460-3963 Fax:(62)021-460-3937

**P.T. TORISHIMA GUNA ENGINEERING**

Jalan Rawa Sumur Timur No.1, Pulogadung  
 Industrial Estate, P.O Box 1160  
 Jakarta Indonesia  
 Phone: (62)021-460-3963 Fax:(62)021-460-3937

**P.T. GETEKA FOUNINDO(Foundry Factory)**

JL Pulo Ayang Kav. AA2 Pulogadung  
 Industrial Estate P.O Box 1160 JAT  
 Jakarta 13011, Indonesia  
 Phone: (62)021-460-3963 Fax: (62)021-460-3937

**TORISHIMA U.A.E.**

**MIDDLE EAST OFFICE**  
 5th Floor, office No.503, Al Salmeen  
 Golden Tower, P.O Box.:72197,  
 Electra Street, Abu Dhabi. U.A.E.  
 Phone: (971)2-6743880 Fax:(971)2-6743881

**TORISHIMA U.K.**

**EUROPE OFFICE**  
 c/o Krg Industries Ltd, Russel Colt St,  
 Coatbridge Lanarkshire ML5 2BN, Scotland  
 Phone: (44)1236 441630 Fax:(44)1236 702875

**TORISHIMA U.S.A.**

**U.S.A. OFFICE**  
 82B Daniels Road, Charlton,  
 MA01507, the United States of America  
 Phone: (1)866-374-1130 Fax:(1)508-248-9321